

THC-B110-P 1 MP EXIR Bullet Camera



Key Features

- 1 MP high-performance CMOS
- 1296 × 732 resolution
- 2.8 mm, 3.6 mm, 6 mm fixed focal lens
- Day/Night switch
- EXIR 2.0, smart IR, up to 20 m IR distance
- Switchable TVI/AHD/CVI/CVBS
- IP66

Specifications

Camera	
Image Sensor	1 MP CMOS image sensor
Signal System	PAL/NTSC
Effective Pixels	1296 (H) × 732 (V)
Min. illumination	0.1 Lux@(F1.2,AGC ON), 0 Lux with IR
Shutter Time	1/25 (1/30) s to 1/50,000 s
Lens	2.8 mm, 3.6 mm, 6 mm
Horizontal Field of View	92° (2.8 mm), 70.9° (3.6 mm), 56.7° (6 mm)
Lens Mount	M12
Day & Night	IR cut filter
Angle Adjustment	Pan: 0° to 360°, Tilt: 0° to 180°, Rotation: 0° to 360°
Synchronization	Internal synchronization
Video Frame Rate	720p@25fps/720p@30fps
HD Video Output	1 analog HD output
S/N Ratio	> 62dB
General	
Operating Conditions	-40 °C to 60 °C (-40 °F to 140 °F), Humidity: 90% or less (non-condensation)
Power Supply	12 VDC ±15%
Power Consumption	Max. 4 W
Protection Level	IP66
Material	Plastic
IR Range	Up to 20 m
Dimensions	65.9 mm × 189.2 mm × 81.8 mm (2.59" × 7.45" × 3.22")
Weight	400 g (0.88 lb.)

Order Model

THC-B110-P

Dimension

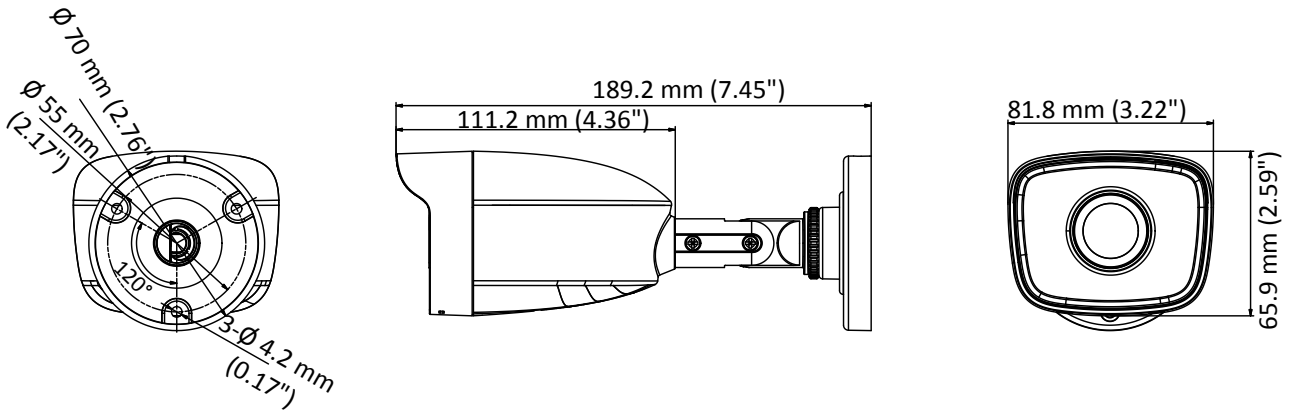

Accessories



DS-1280ZI-XS
Junction Box



DS-1H18
Video Balun